

The history of revision change for the specification

Date	Revision	Changes
2021/09/02	A0	New approval
2021/12/07	A1	Add type designation note
2022/02/18	A2	Update TCR specifications

1/10W, 0402, Thick Film Chip Resistor

Features / Applications :

- Lead free meet RoHS compliant, Halogen free
- AEC-Q200 qualified
- Automotive applications

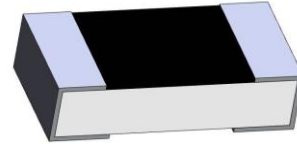

Electrical Specifications :

Power Rating*	Resistance Values Series	Resistance Tolerance	Resistance Range (Ω)	Temperature Coefficient of Resistance (ppm /°C)	Operating Temperature Range	Max. Operating Voltage**
1/10W	E24 series & E96 series	± 0.5% (D)	1.0~9.76	± 200	-55°C to 155°C	50V
		± 1.0% (F)				
		± 2.0% (G)	10~10M	± 100		
		± 5.0% (J)				
Jumper	Resistance		Rated current		Operating Temperature Range	
	Below 50 mΩ		1A		-55°C to 155°C	

Note: *Package Power Temperature Derating Curve

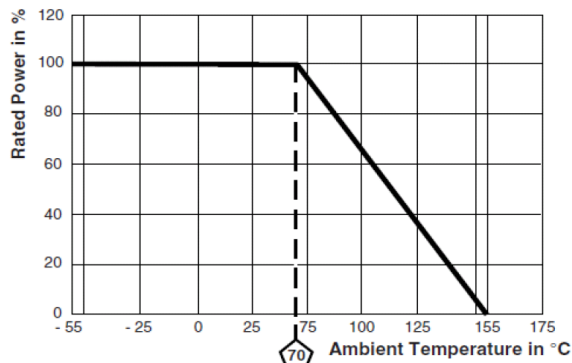

Figure 1. : Power Temperature Derating Curve

Note: **Resistors shall have a rated DC or AC(rms.) continuous operating voltage corresponding to the power rating, as calculated from the following formula

$$V = \sqrt{P \times R}$$

Where V : Rated voltage (V)

P : Rated power (W)

R : Nominal resistance (Ω)

If the voltage so obtained exceeds the maximum operating voltage, this maximum voltage shall be the rated voltage.

Outline Drawing :

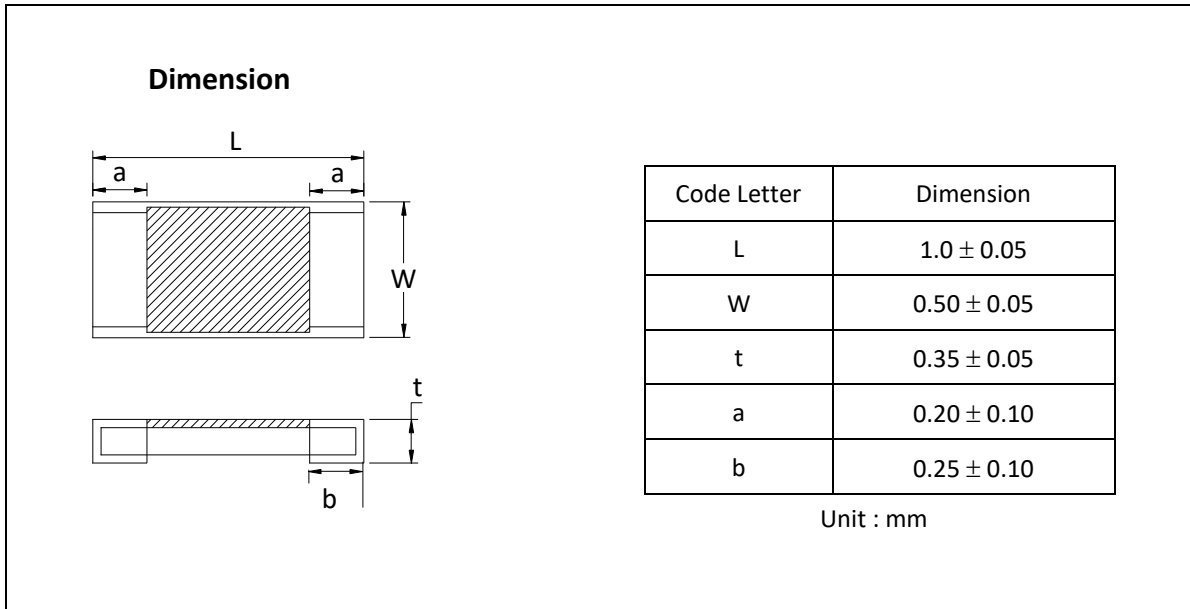

Type Designation :

VRNS H N - XXXX - X
 (1) (2) (3) (4) (5)

Note :

- (1) Series No. = Automotive
- (2) Size : H = 0402
- (3) Power Rating : N = 1/10W
- (4) Resistance value : 000 = Jumper ; 103 = 10 kΩ (E24) ; 1131 = 1.13kΩ (E96)
- (5) Tolerance : D = ±0.5% ; F = ±1% ; G = ±2% ; J = ±5% ; X = Jumper

Note: If the resistance value of E24 and E96 coincide, E24 shall prevail.

Characteristics :

Electrical

Item	Specification and Requirement		Test Method
	Resistor	Jumper	
Temperature Coefficient (TCR)	As follow specification		JIS-C-5201 +25°C/ +125°C.
Short Time Overload	$\Delta R: \pm(1.0\% + 0.05\Omega)$ Without damage by flashover, spark, arcing, burning or breakdown	Max. 50m Ω	JIS-C-5201-1 4.13 2.5 x rated voltage for 5 seconds.
ESD	$\Delta R: \pm(1.0\% + 0.05\Omega)$	Max. 50m Ω	AEC-Q200-002 Human body, 0.5KV.

Mechanical

Item	Specification and Requirement		Test Method
	Resistor	Jumper	
Solderability	The surface of terminal immersed shall be minimum of 95% covered with a new coating of solder		J-STD-002 1.155°C/4hr→245±5°C for 3sec 2.SA 4hr→245±5°C for 3sec 3.SA 4hr→260±5°C for 30sec
Resistance to Solder Heat	ΔR: ±(1.0% + 0.05Ω)	Max. 50mΩ	MIL-STD-202 Method 210 Temperature: 270°C, Dipping time: 10sec.
Vibration	ΔR: ±(0.5% + 0.05Ω) Without distinct damage in appearance	Max. 50mΩ	MIL-STD-202 Method 204 5G's for 20 minutes, 12 cycles each of 3 orientations. Test from 10-2000Hz.
Mechanical Shock	ΔR: ±(0.5% + 0.05Ω) Without distinct damage in appearance	Max. 50mΩ	MIL-STD-202 Method 213 100G's peak value, 6ms, Half-sine waveform, 12.3ft/sec.
Board flex	ΔR: ±(1.0% + 0.05Ω) Without mechanical damage such as break	Max. 50mΩ	AEC-Q200-005 Flexure holding time:60sec, 2mm
Terminal strength	a. Without mechanical damage such as break b. Judgement standard : Ac/Re= 0/1		AEC-Q200-006 Shear force:9N, duration:60sec

Endurance

Item	Specification and Requirement		Test Method
	Resistor	Jumper	
Temperature Cycling	$\Delta R: \pm(1.0\% + 0.05\Omega)$	Max. 50m Ω	JESD22 Method JA-104 1000 cycles, (-55°C~125°C) 30 min maximum dwell time at each temperature.
Biased Humidity	$\Delta R: \pm(3.0\% + 0.05\Omega)$	Max. 50m Ω	MIL-STD-202 Method 103 1000 hours, 85°C/85%R.H, applied for 10% rated power.
Damp heat, steady state	$\Delta R: \pm(3.0\% + 0.05\Omega)$	Max. 50m Ω	IEC 60068-2 (40 \pm 2) °C; (93 \pm 3) % RH; 56 days.
Operational Life	$\Delta R: \pm(3.0\% + 0.05\Omega)$	Max. 50m Ω	MIL-STD-202 Method 108 Temperature:70°C, duration:1000hrs, 1.5Hour ON, 0.5Hour OFF Load condition: Rated power.
High temperature exposure	$\Delta R: \pm(1.0\% + 0.05\Omega)$	Max. 50m Ω	MIL-STD-202 Method 108 Temperature:155°C(Refer to spec) Duration:1000hrs
Resistance to solvents	Without mechanical and distinct damage in appearance		MIL-STD-202 method 215 Type of solvents: Aqueous wash chemical. OKEM clean or equivalent. Do not use banned solvents.

Note : Measurement at 24 \pm 4 hours after test conclusion for all reliability tests-parts.

Recommend Land Pattern Dimensions :

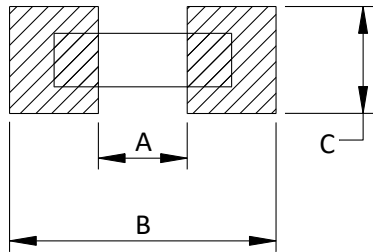

A	0.5
B	1.5
C	0.4~0.6

Unit : mm

TAPE PACKAGING DIMENSIONS:

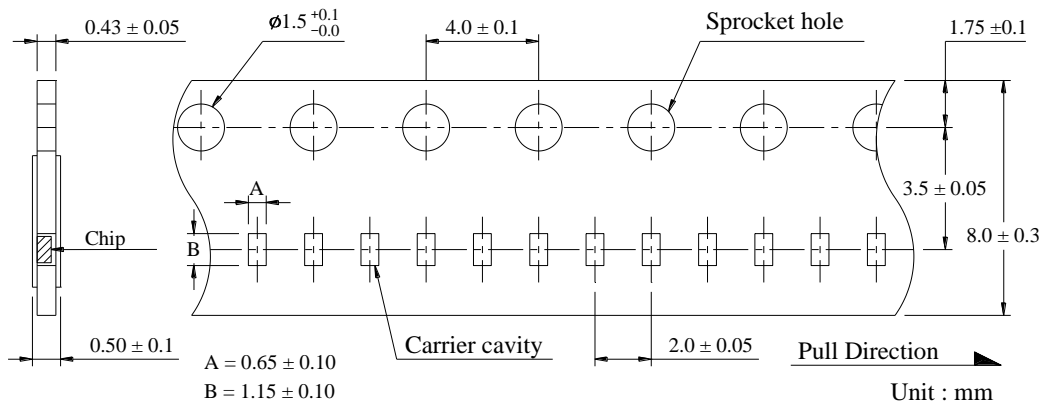

REEL DIMENSIONS:

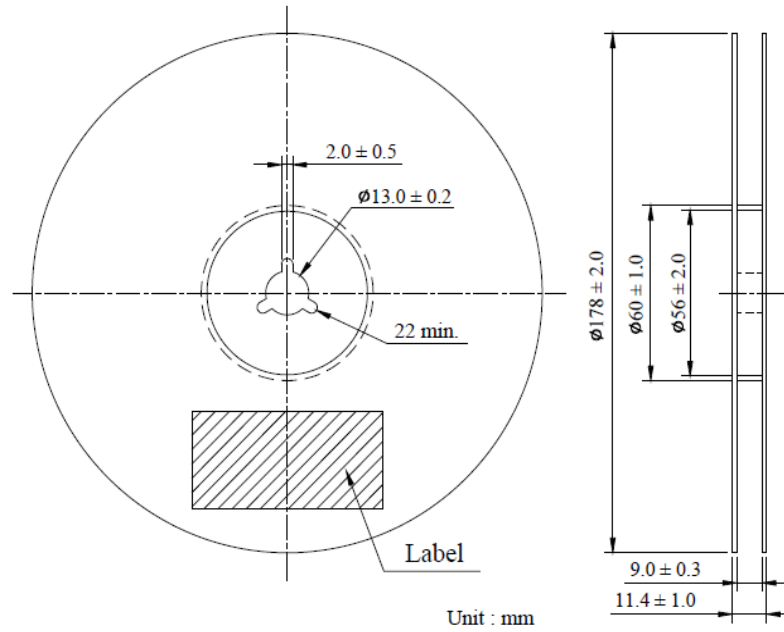

Numbers of Taping: 10,000 pieces/reel

The following items shall be marked on the reel.

- (1) Type designation.
- (2) Quantity
- (3) Manufacturing date code
- (4) Manufacturer's name

Peel force of top cover tape

The peel speed shall be about 300 mm/min. The peel force of top cover tape shall be between 0.1 to 0.7 N.

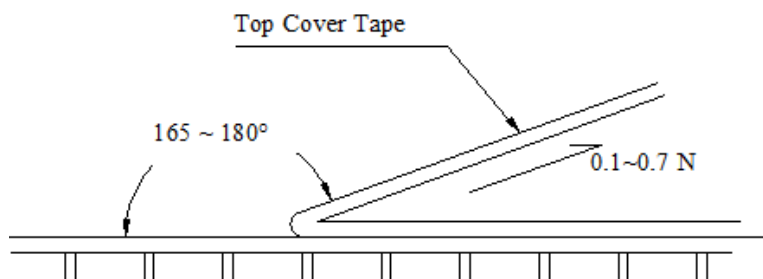

Care Note :

Care note for storage

- (1) Chip resistor shall be stored in a room where temperature and humidity must be controlled.
(temperature 5 to 35°C, humidity 30% to 80% RH) However, a humidity keep it low, as it is possible.
- (2) Chip resistor shall be stored as direct sunshine doesn't hit on it.
- (3) Chip resistor shall be stored with no moisture, dust, a material that will make solderability inferior, and a harmful gas (Hydrogen chloride, sulfurous acid gas, and Hydrogen sulfide)

Care note for operating and handling

- (1) It is necessary to protect the edge and protection coat of resistors from mechanical stress.
- (2) Handle with care when printing circuit board (PCB) is divided or fixed on support body, because bending of printing circuit board (PCB) mounting will make mechanical stress for resistors.
- (3) Resistors shall be used with in rated range shown in specification. Especially, if voltage more than specified value will be loaded to resistor, there is a case it will make damage for machine because of temperature rise depending on generating of heat, and increase resistance value or breaks.
- (4) In case that resistor is loaded a rated voltage, it is necessary to confirms temperature of a resistor and to reduce a load power according to load reduction curve, because a temperature rise of a resistor depends on influence of heat from mounting density and neighboring element.
- (5) Observe Limiting element voltage and maximum overload voltage specified in each specification.
- (6) If there is possibility that a large voltage (pulse voltage, shock voltage) charge to resistor, it is necessary that operating condition shall be set up before use.